

Description

The DFPSM05 is an uni-directional TVS diode array, utilizing leading monolithic silicon technology to provide fast response time and low ESD clamping voltage, making this device an ideal solution for protecting sensitive semiconductor components from damage. The DFPSM05 complies with the IEC 61000-4-2 (ESD) standard with $\pm 30\text{kV}$ air and $\pm 30\text{kV}$ contact discharge. It is assembled into a lead-free SOT-23 package. It is designed to protect components which are connected to data and transmission lines from voltage surges.

Mechanical Characteristics

- ◆ Package: SOT-23
- ◆ Lead Finish: Matte Tin
- ◆ Case Material: "Green" Molding Compound.
- ◆ Moisture Sensitivity: Level 3 per J-STD-020
- ◆ Terminal Connections: See Diagram Below
- ◆ Marking Information: See Below

Dimensions and Pin Configuration

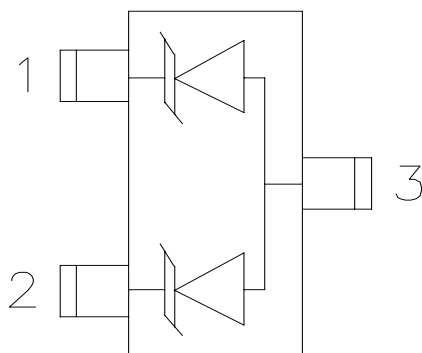

SOT23

Circuit and Pin Schematic

Features

- ◆ 60W peak pulse power(8/20 μs)
- ◆ Protects one two uni-directional line(s)
- ◆ Ultra low leakage: nA level
- ◆ Operating voltage: 5V
- ◆ Low clamping voltage
- ◆ Complies with following standards:
 - IEC 61000-4-2 (ESD) immunity test
 - Air discharge: $\pm 30\text{kV}$
 - Contact discharge: $\pm 30\text{kV}$
 - IEC61000-4-5 (Lighting) 5A (8/20 μs)
- ◆ RoHS Compliant

Applications

- ◆ Peripherals
- ◆ Industrial Equipment
- ◆ Notebook Computers
- ◆ Portable Instrumentation
- ◆ Microprocessor Based Equipment
- ◆ Cell Phone Handsets and Accessories
- ◆ Personal Digital Assistants(PDAs) and Pagers

Marking Information

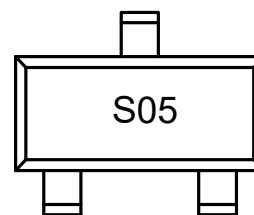

Ordering Information

Part Number	Marking	Packaging	Reel Size
DFPSM05	S05	3000/Tape & Reel	7 inch

Absolute Maximum Ratings ($T_A=25^{\circ}\text{C}$ unless otherwise specified)

Parameter	Symbol	Value	Unit
Peak Pulse Power (8/20 μs)	Ppk	60	W
Peak Pulse Current (8/20 μs)	Ipp	5	A
ESD per IEC 61000-4-2 (Air)	VESD	± 30	kV
ESD per IEC 61000-4-2 (Contact)		± 30	
Operating Temperature Range	TJ	-55 to +125	$^{\circ}\text{C}$
Storage Temperature Range	Tstg	-55 to +150	$^{\circ}\text{C}$

Electrical Characteristics ($T_A=25^{\circ}\text{C}$ unless otherwise specified)

Parameter	Symbol	Min	Typ	Max	Unit	Test Condition
Reverse Working Voltage	VRWM			5	V	
Breakdown Voltage	VBR	6			V	IT = 1mA
Reverse Leakage Current	IR			0.2	μA	VRWM = 5V
Forward Voltage	VF		1.0	1.2	V	IF = 10mA
Clamping Voltage	VC		12	14	V	Ipp = 5A (8 x 20 μs pulse)
Junction Capacitance	CJ		33	40	pF	VR = 0V, f = 1MHz

Typical Performance Characteristics (TA=25°C unless otherwise Specified)

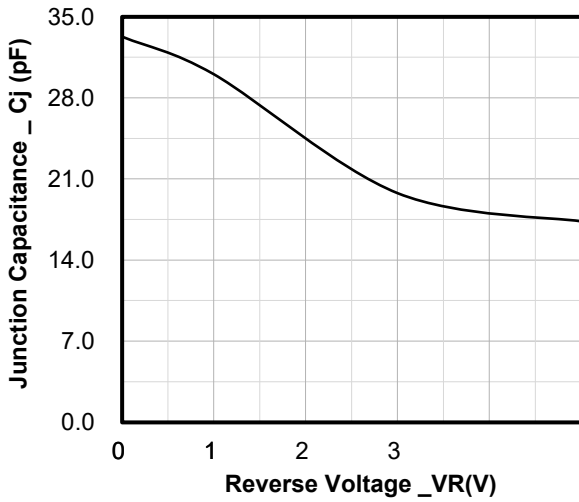

Junction Capacitance vs. Reverse Voltage

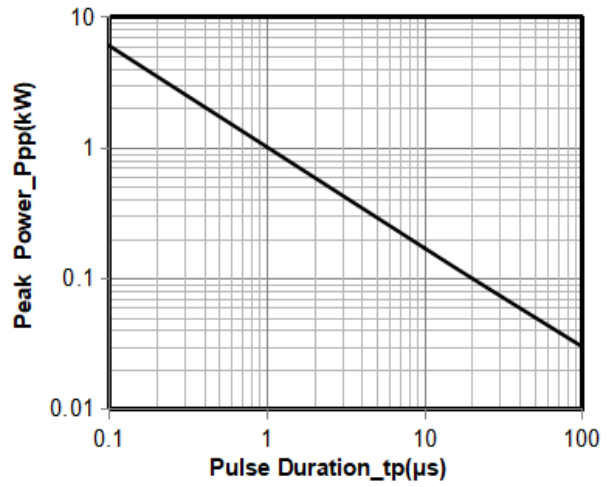

Peak Pulse Power vs. Pulse Time

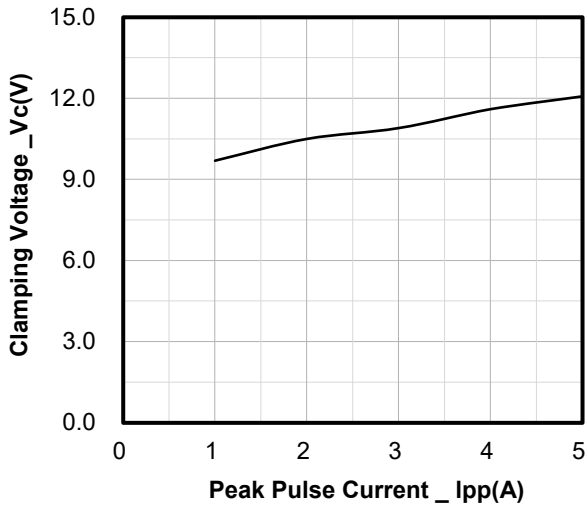

Clamping Voltage vs. Peak Pulse Current

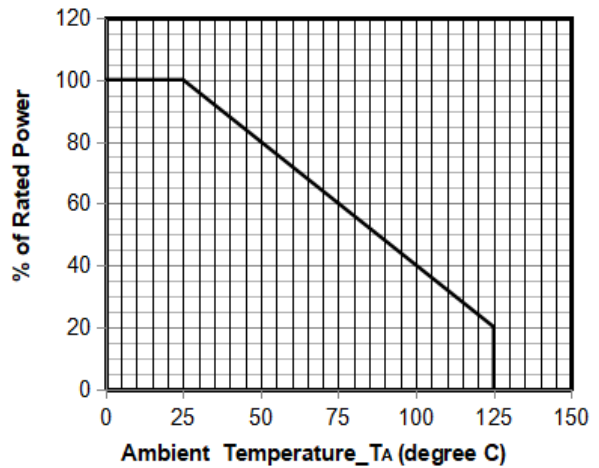

Power Derating Curve

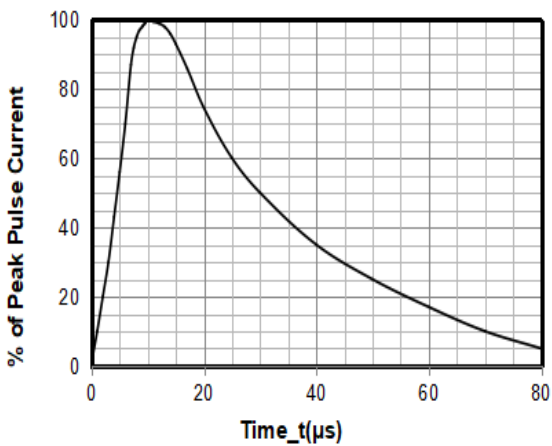

8 X 20μs Pulse Waveform

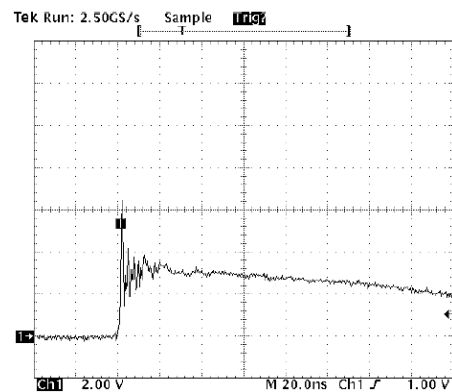

Note: Data is taken with a 10x attenuator

ESD Clamping Voltage

8 kV Contact per IEC61000-4-2

SOT-23 Package Outline Drawing

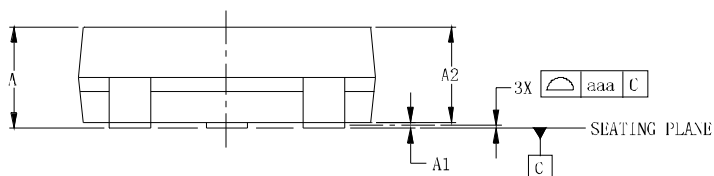
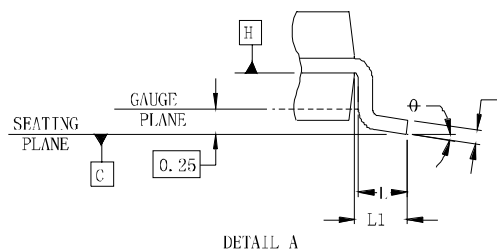
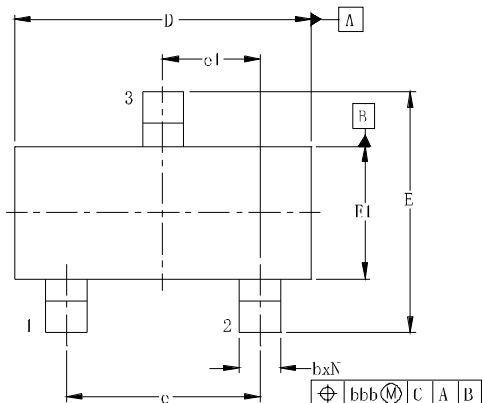

Suggested Land Pattern

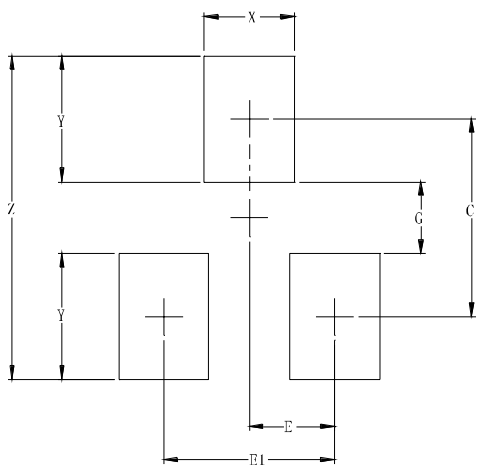

DIMENSIONS						
SYM	INCHES			MILLIMETERS		
	MIN	NOM	MAX	MIN	NOM	MAX
A	0.035	-	0.044	0.89	-	1.12
A1	0.000	-	0.004	0.01	-	0.10
A2	0.035	0.037	0.040	0.88	0.95	1.02
b	0.012	-	0.020	0.30	-	0.51
c	0.003	-	0.007	0.08	-	0.18
D	0.110	0.114	0.120	2.80	2.90	3.04
E	0.082	0.093	0.104	2.10	2.37	2.64
E1	0.047	0.051	0.055	1.20	1.30	1.40
e	0.075			1.90BSC		
e1	0.037			0.95BSC		
L	0.015	0.020	0.024	0.40	0.50	0.60
L1	0.022			0.55		
N	3			3		
φ	0°	-	8°	0°	-	8°
aaa	0.004			0.10		
bbb	0.008			0.20		

DIMENSIONS		
SYM	INCHES	MILLIMETERS
C	0.087	2.20
E	0.037	0.95
E1	0.075	1.90
G	0.031	0.80
X	0.039	1.00
Y	0.055	1.40
Z	0.141	3.60

Contact Information

Changzhou D-first Electronics CO.,Ltd.

www.first-electronic.com

Email: xhf@first-electronic.cn

Phone: +86 (0519) 8817 1671